













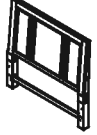
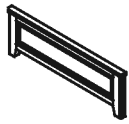

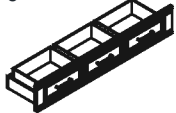

**INTERCON**  
FURNITURE FOR LIFE

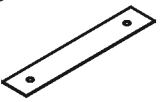
# ASSEMBLY INSTRUCTION

DESCRIPTION: QUEEN PANEL BED

ITEM NO: CR-BR-9765Q-WSL-HB / CR-BR-9765Q-WSL-FB  
CR-BR-9765QK-WSL-RS / CR-BR-9765S-WSL-RS

Thank you for purchasing this quality product. Be sure to check all packing material carefully for small parts which may have come loose inside the carton during shipment. Identify and count all parts and compare with the parts list below. Please keep all hardware out of reach of small children.

1  HEADBOARD 1 PC	2  FOOTBOARD 1 PC	3  SLAT 5 Pcs	4  SUPPORT LEGS 5 Pcs	5  Q/K SIDE RAILS 2 Pcs	6  Q/K STORAGE RAILS 2 Pcs	7  SUPPORT LEGS 5 Pcs	8  DECKING PANEL 4 Pcs
A  BLOT 5/16" x 3" 8 Pcs	B  SPRING WASHER 5/16" 8 Pcs	C  FLAT WASHER 5/16" 8 Pcs	D  HALF MOON WASHER 29 x 15 x 7.5mm 8 Pcs	E  HEX NUT Ø5/16" x 12mm 8 PC	F  WRENCH 1 PC	G  WOOD SCREW #8 x 1" 10 Pcs	 SCREWDRIVER NOT PROVIDED

## STEP 1

### QUEEN BED WITH Q/K STANDARD RAILS

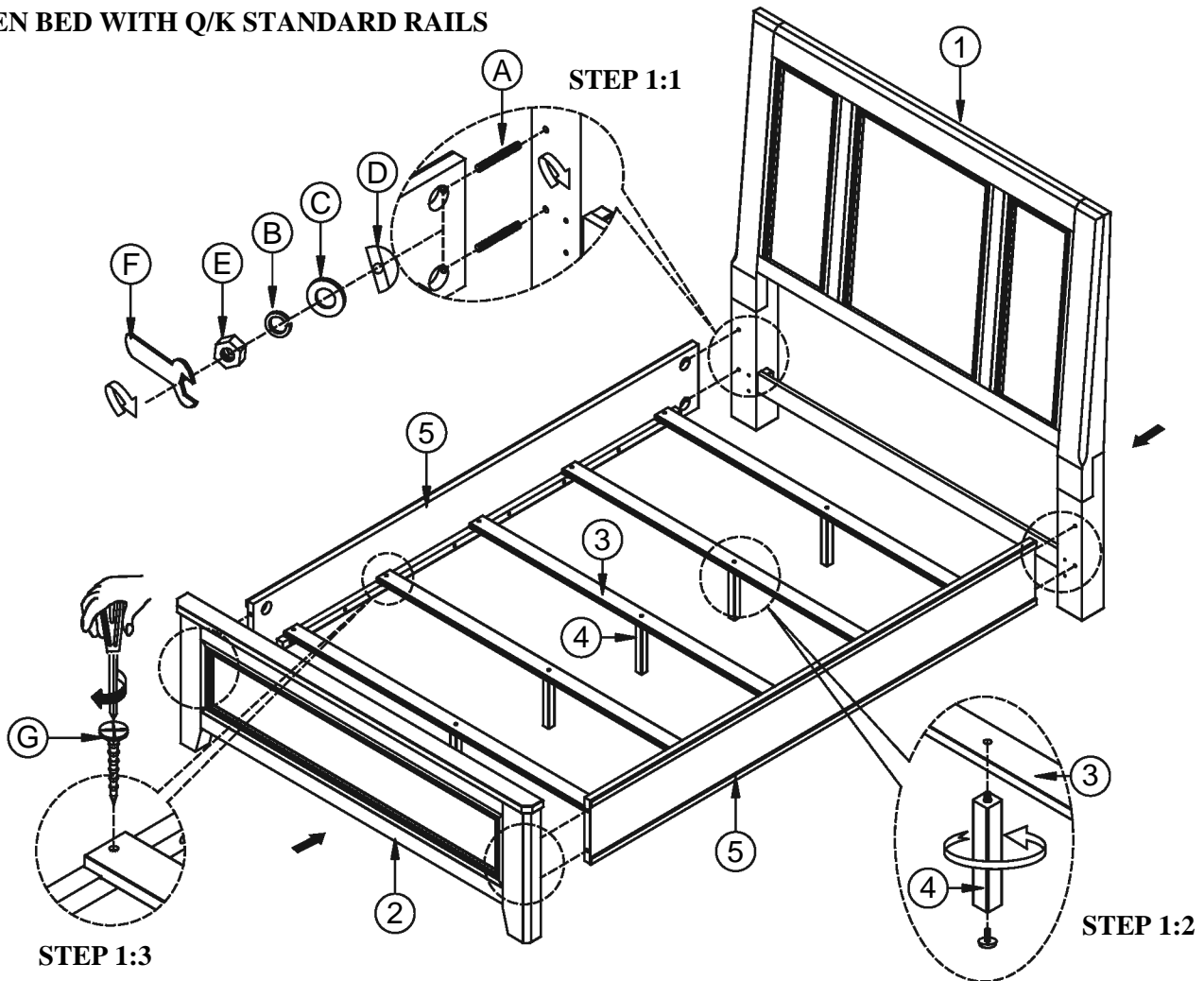

#### ASSEMBLY TIPS:

1. Remove hardware from box and sort by size.
2. Please check to see that all hardware and parts are present prior start of assembly.
3. Please follow attached instructions in the same sequence as numbered to assure fast and easy assembly.

#### ⚠ WARNING!

1. Don't attempt to repair or modify parts that are broken or defective. Please contact the store immediately.
2. This product is for home use only and not intended for commercial establishments.



**INTERCON**  
FURNITURE FOR LIFE

# ASSEMBLY INSTRUCTION

DESCRIPTION: QUEEN PANEL BED

ITEM NO: CR-BR-9765Q-WSL-HB / CR-BR-9765Q-WSL-FB  
CR-BR-9765QK-WSL-RS / CR-BR-9765S-WSL-RS

Thank you for purchasing this quality product. Be sure to check all packing material carefully for small parts which may have come loose inside the carton during shipment. Identify and count all parts and compare with the parts list below. Please keep all hardware out of reach of small children.

## STEP 1

### QUEEN BED WITH Q/K STORAGE RAILS

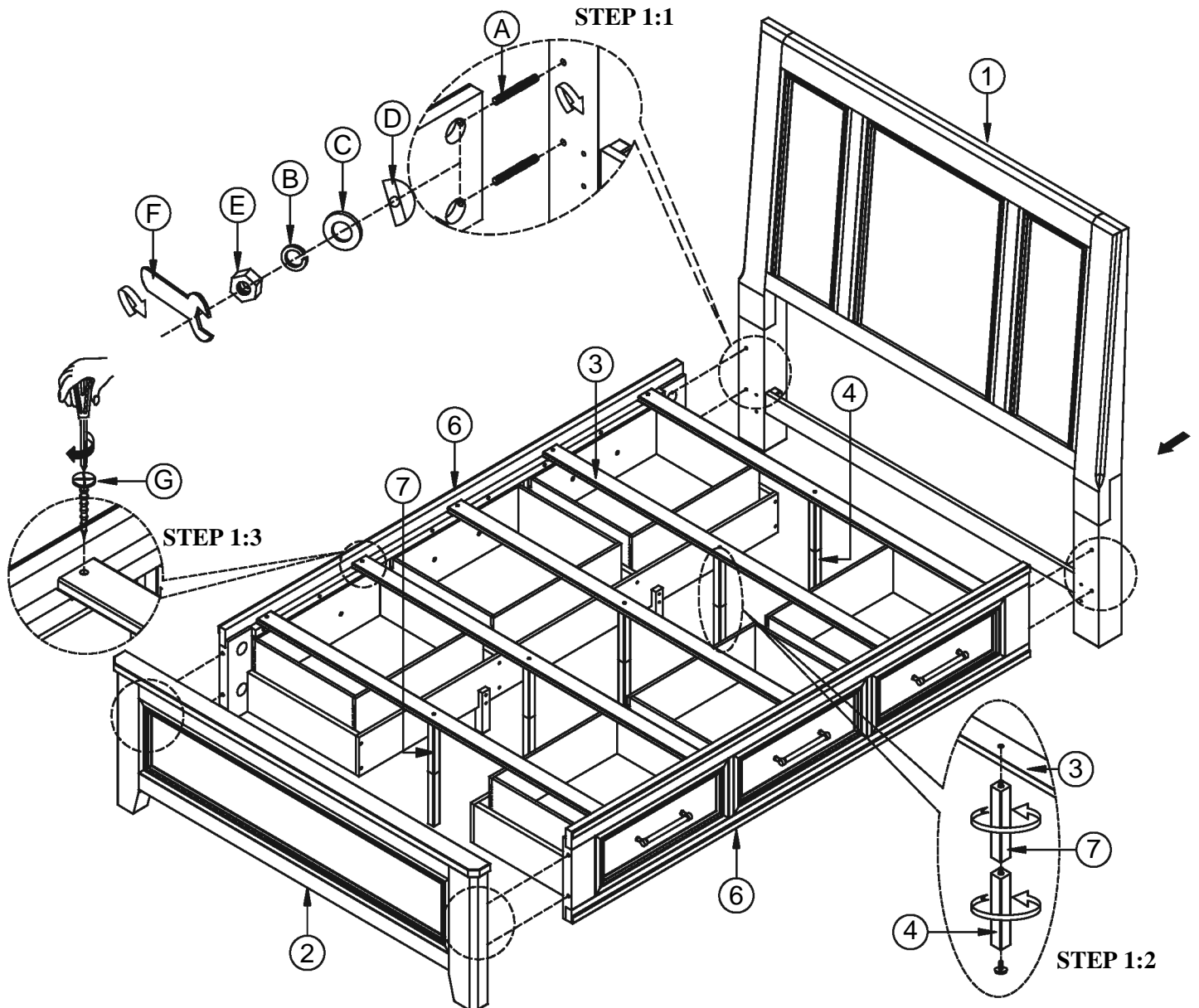

#### ASSEMBLY TIPS:

1. Remove hardware from box and sort by size.
2. Please check to see that all hardware and parts are present prior start of assembly.
3. Please follow attached instructions in the same sequence as numbered to assure fast and easy assembly.

#### **⚠ WARNING!**

1. Don't attempt to repair or modify parts that are broken or defective. Please contact the store immediately.
2. This product is for home use only and not intended for commercial establishments.



**INTERCON**  
FURNITURE FOR LIFE

# ASSEMBLY INSTRUCTION

DESCRIPTION: QUEEN PANEL BED

ITEM NO: CR-BR-9765Q-WSL-HB / CR-BR-9765Q-WSL-FB  
CR-BR-9765QK-WSL-RS / CR-BR-9765S-WSL-RS

Thank you for purchasing this quality product. Be sure to check all packing material carefully for small parts which may have come loose inside the carton during shipment. Identify and count all parts and compare with the parts list below. Please keep all hardware out of reach of small children.

## STEP 2

### QUEEN BED WITH Q/K STORAGE RAILS

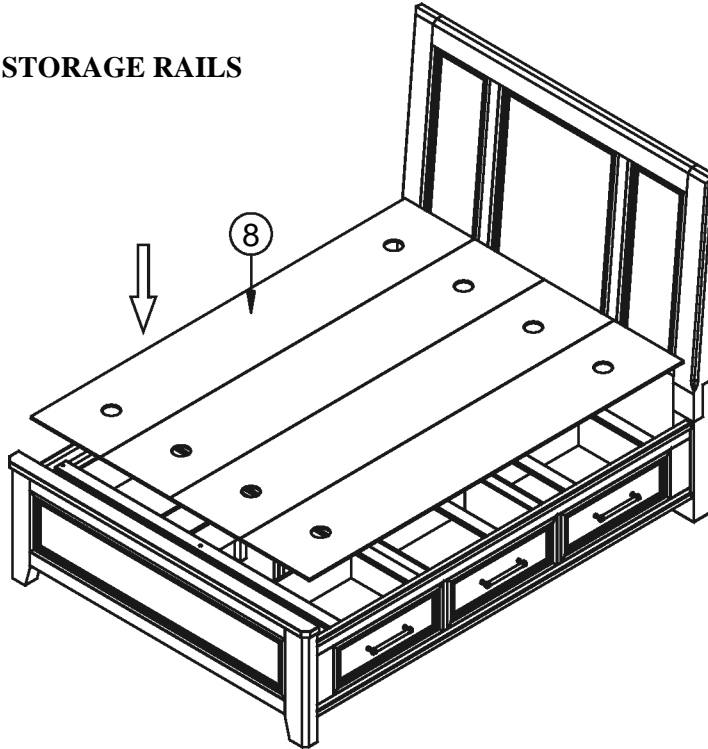

### QUEEN BED WITH Q/K STANDARD RAILS

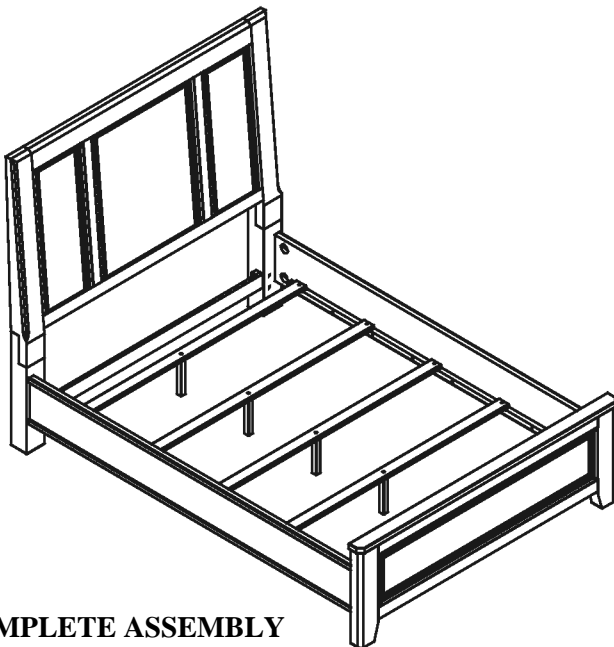

**COMPLETE ASSEMBLY**

### QUEEN BED WITH Q/K STORAGE RAILS

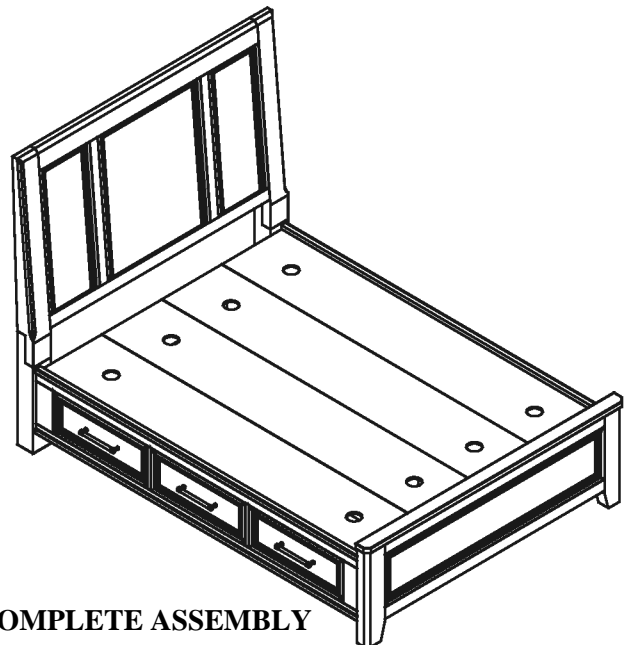

**COMPLETE ASSEMBLY**

#### ASSEMBLY TIPS:

1. Remove hardware from box and sort by size.
2. Please check to see that all hardware and parts are present prior start of assembly.
3. Please follow attached instructions in the same sequence as numbered to assure fast and easy assembly.

#### WARNING!

1. Don't attempt to repair or modify parts that are broken or defective. Please contact the store immediately.
2. This product is for home use only and not intended for commercial establishments.